

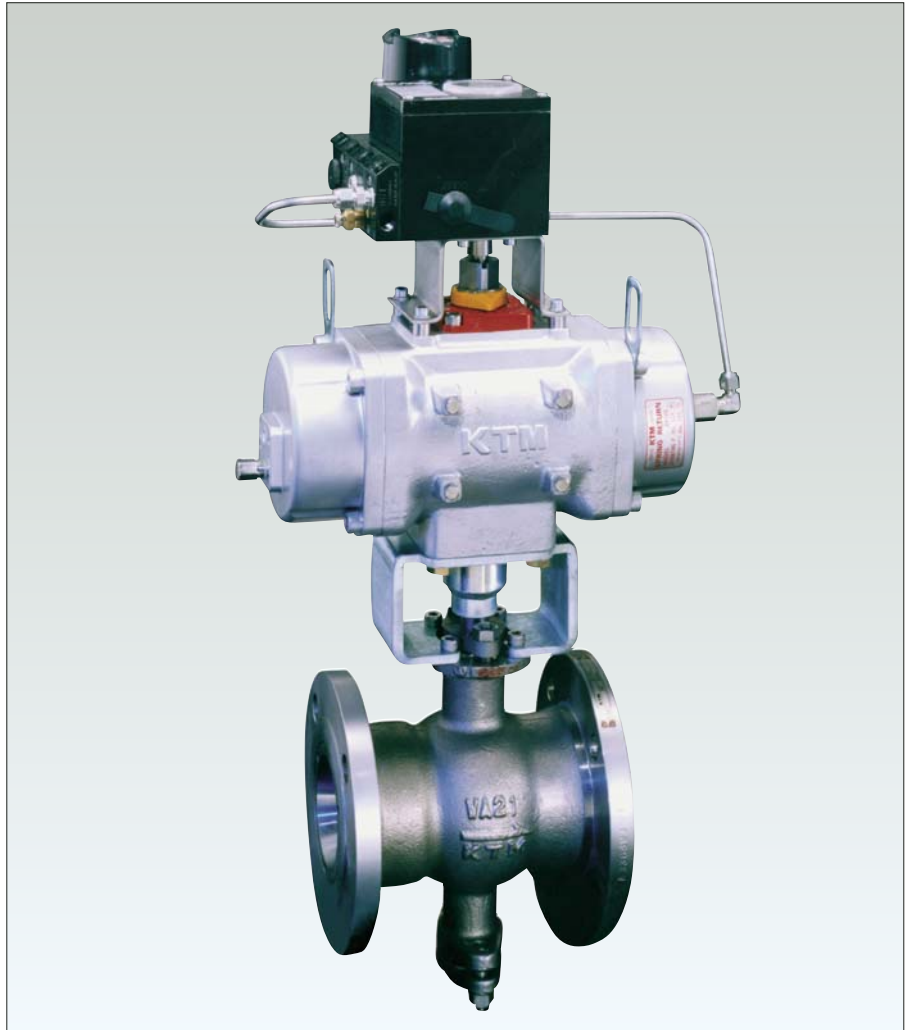

Enhanced, proven design offers both control and block valve functions

Features

- Unique Dual-V ball features a secondary (Small) V-Notch allowing extremely small, accurate flow rates
- The primary (Large) V-notch provides straight through and non-clogging flow
- Dual-V ball allows rate changes and controls fluids with a rangeability in 250:1
- Equal percent flow characteristic
- Rotary-valve design provides shearing action between the V-notch ball and the seat, promoting a smooth, non-clogging operation
- Spring loaded stellited metal seat
- ANSI / FCI 70-2 Class V
- Unibody design protect from the effect of piping stress
- Minimum body cavity reduces build-up
- Fugitive emissions control for flammable and non-flammable applications
- Available in flangeless or flanged construction
- Multiple, adjustable ring packing allows easy adjustment without valve disassembly or actuator removal
- ISO mounting pad is available as optional
- Positive position indication



General Applications

Slurry and viscous fluids, powder (option) and pellet, sludge in water treatment and pollution control processes, chips and fibers in pulp and paper process, flow control in pipeline and transmissions, pressure control in oil and gas

Options

- Special tests
 - Radiography test (RT)
 - Liquid penetrant test (PT)
 - Positive material inspection (PMI)

Technical Data

Models	: WA20, WA21, WA22
Sizes	: 25mm to 200mm (1" to 8")
Pressure rating	: JIS 10K, 20K / ASME Class 150, 300 (JPI available)
Face to face	: Flanged type ASME B16.10 (short pattern) : Flangeless type ISA 75.04
End connection	: JIS B2220 : ASME B16.5 RF
Temperature	: -20°C to 270°C
Seat leakage	: ANSI / FCI 70-2 Class V

KTM Dual V High Performance Control Ball Valves

Flanged and Flangeless

Integral Mounting Pad

Machined "actuator pad" allows precise mounting of actuator. Mounting bolts are independent from the stem-packing gland bolts. This exact alignment reduces torque and prevents out-of-line wear on the stem and packing (Option).

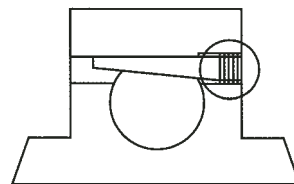
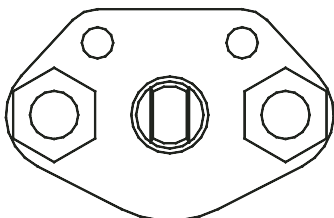

Stem to Disc Connection

A tapered pin connection is used to ensure accurate control of flow, which also results in a high resolution of 250:1.

Fugitive Emissions Control Packages

Available for both flammable and non-flammable service.

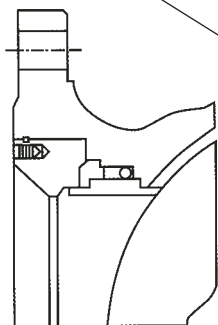

Positive Locking, End Cap Retention

Wire-ring with three point locking device assures tight fit.

Versatile End-Connection

The Unibody design is available in flangeless or flanged construction and meets ISA S-75.04 and ASME B16.10 (Short pattern) face-to-face dimensions.

Unique Dual-V Ball

A secondary (Small) V-Notch allows extremely small, accurate flow rates with the additional benefit of the primary (Large) V-ball providing straight through, non-clogging flow which, if necessary, will shear slurries and fibers.

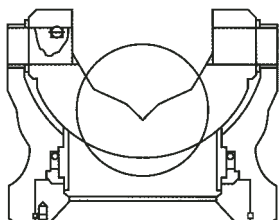

Unibody Design

This proven structural design enhances piping integrity by reducing stress and additionally eliminates potential leak paths.

Minimum Body Cavity

Reduces build-up of transition process materials and the segmented V-ball eliminates freeze-up.

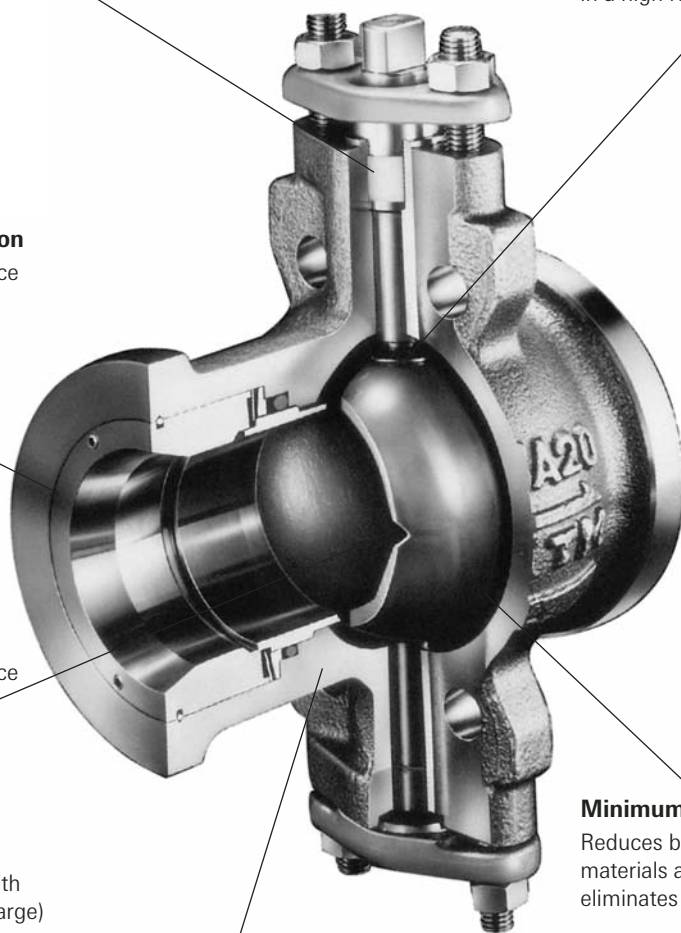
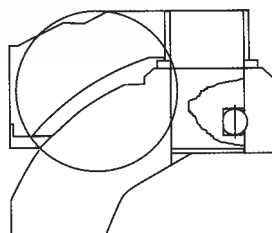

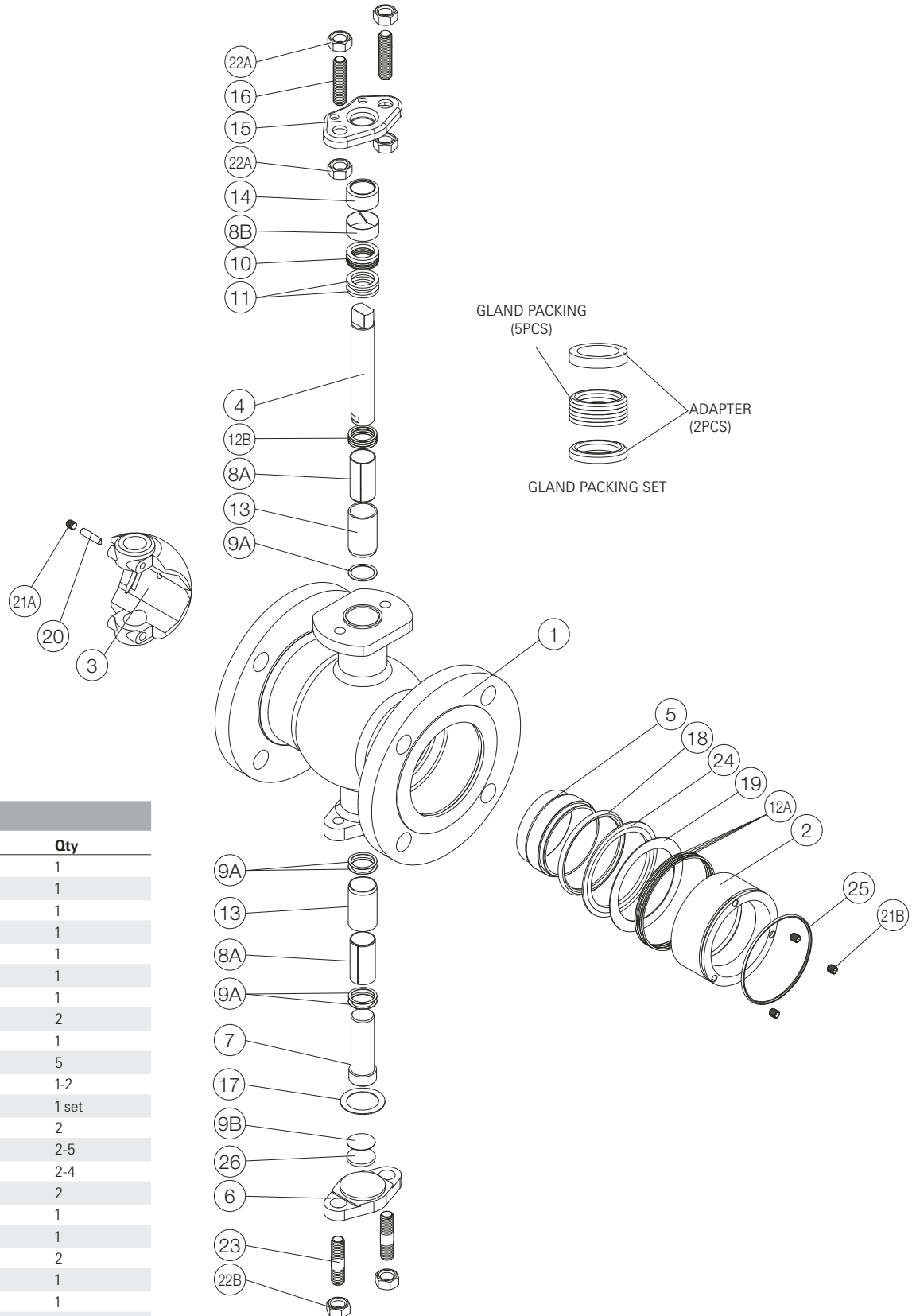

Parts list

No.	Parts name	Qty
1	Body	1
2	Body Cap	1
3	Disk	1
4	Stem	1
5	Seat	1
6	Lower Cover	1
7	Lower Stem	1
8A	Stem Bearing	2
8B	Stem Bearing	1
9A	Thrust Bearing	5
9B	Thrust Bearing	1-2
10	Gland Packing	1 set
11	Thrust Washer	2
12A	Shim	2-5
12B	Shim	2-4
13	Bearing Holder	2
14	Gland	1
15	Gland Flange	1
16	Gland Bolt	2
17	Gasket	1
18	Seal Ring	1
19	Spring	1
20	Taper Pin	1
21A	Set Screw	1
21B	Set Screw	3
22A	Nut	4
22B	Nut	2-4
23	Stud	2-4
24	Stopper	1
25	Locking Ring	1
26	Thrust Washer	1

KTM Dual V High Performance Control Ball Valves

Flanged and Flangeless

Seat design

The precision finished heavy duty "V" ball surface and spring supported, stellite metal seat combination provides excellent sealing performance with low torque. It also offers the additional benefit of exceptional wear and pressure drop performance over a wide range of media - steam, gas, liquid, fiber and slurry applications.

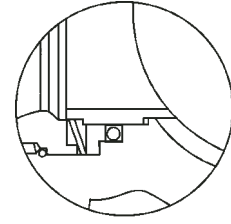

Class V
Spring loaded stellite seat

Available trims

Application	General purpose	Abrasion resistant	Corrosion resistant	Corrosion & abrasion resistant	Abrasion & high temp resistant
Trim combination	AV	BV	AT	BT	BP
Operating temp	-20°C to 150°C		-20°C to 200°C		-20°C to 270°C
Body material	CF8 (SCS13A), CF8M (SCS14A)				
V-Ball material	CF8M (SCS14A)+ HCr	CF8M (SCS14A)+ SFNi	CF8M (SCS14A)+ HCr	CF8M (SCS14A)+ SFNi	
Seat material	316 SS + Stellite				
Seat seal material	FKM O-ring		PTFE seal-ring		PEEK seal-ring
Stem Bearing	Metal-backed PTFE				Stellite bushing
Packing	PTFE				Graphite

- HCr: Hard chromium plating SFNi: Nickel alloy overlay
- Material in parentheses indicate equivalent JIS material.

C_v Values

Valve Size (mm)	Percent Open									
	10	20	30	40	50	60	70	80	90	100
25	0.16	0.33	1.2	2.3	4.1	6.6	10.2	15.8	23.4	33
40	0.45	0.90	3.2	6.3	11.3	18.0	27.9	43.2	63.9	90
50	0.83	2.50	5.8	11.6	20.6	33.0	51.2	79.2	117.0	165
65	1.40	4.10	9.6	19.3	34.4	55.0	85.3	132.0	195.0	275
80	1.80	5.50	12.8	25.6	45.6	73.0	113.0	175.0	259.0	365
100	3.00	9.00	21.0	42.0	75.0	120.0	186.0	288.0	426.0	600
125	3.80	11.40	26.6	53.2	95.0	152.0	236.0	365.0	540.0	760
150	6.50	19.50	45.5	91.0	163.0	260.0	403.0	624.0	923.0	1,300
200	10.40	31.40	72.8	146.0	260.0	416.0	645.0	998.0	1,480.0	2,080

Inherent flow characteristics

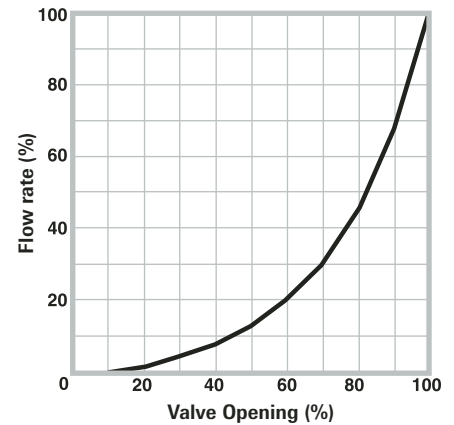

C_v valve curve

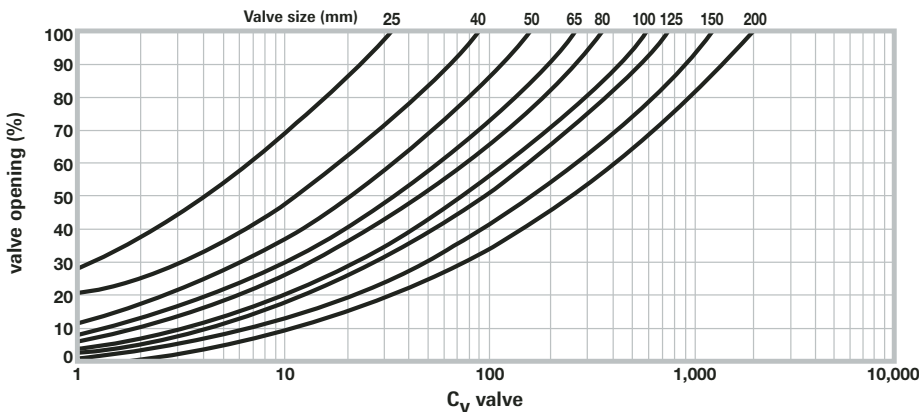

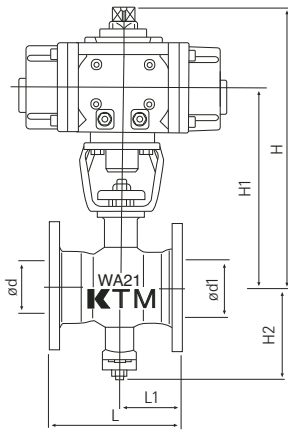

**Flanged
WA21, WA22**

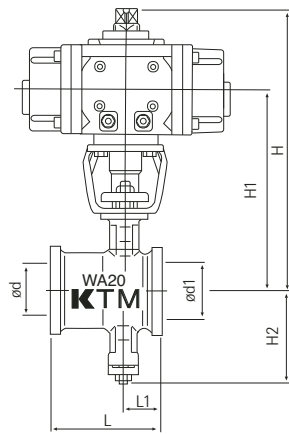

**Flangeless
WA20**

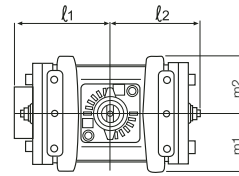

AK 05

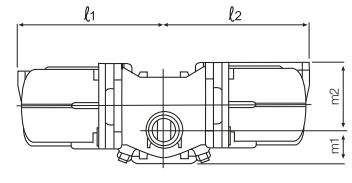

AWN 13

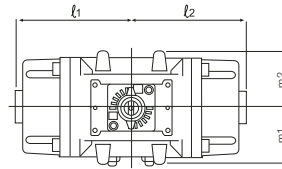

AK 07, 09, 12, 15

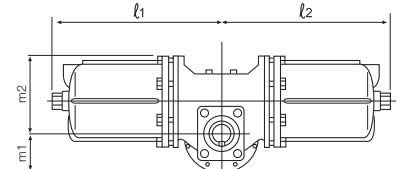

AW 17, 20

Dimensions (WA21, WA22, WA20)

Valve size (mm)	Valve size (inch)	Cylinder actuator	ød	ød1	Flange		Flangeless		H	H1	H2	Cylinder for Double Acting			
					L	L1	L	L1				ℓ1	ℓ2	m1	m2
25	1	AK05	25	44	127	61.0	102	36	251	162	72	84.5	80.5	50	50
		AK07							251	162	72	115.5	115.5	50	50
		AK09							277	178	72	131.5	131.5	50	50
40	1½	AK05	38	52	165	91.0	114	40	272	183	90	84.5	80.5	50	50
		AK07							272	183	90	115.5	115.5	50	50
		AK09							298	199	90	131.5	131.5	50	50
		AK12							356	236	90	157.0	157.0	77	75
50	2	AK05	51	66	178	98.0	124	44	282	193	110	84.5	80.5	50	50
		AK07							282	193	110	115.5	115.5	50	50
		AK09							308	209	110	131.5	131.5	50	50
		AK12							366	246	110	157.0	157.0	77	75
		AK15							395	260	110	195.0	195.0	94	90
65	2½	AK07	64	80	190	100.0	143	53	310	221	131	115.5	115.5	50	50
		AK09							336	237	131	131.5	131.5	50	50
		AK12							407	287	131	157.0	157.0	77	75
		AK15							436	301	131	195.0	195.0	94	90
80	3	AK07	76	84	203	95.0	165	57	331	232	139	115.5	115.5	50	50
		AK09							347	248	139	131.5	131.5	50	50
		AK12							418	298	139	157.0	157.0	77	75
		AK15							447	312	139	195.0	195.0	94	90
100	4	AK09	102	104	229	112.0	194	77	372	273	149	131.5	131.5	50	50
		AK12							427	307	149	157.0	157.0	77	75
		AK15							456	321	149	195.0	195.0	94	90
		AWN13							479	322	149	287.0	287.0	68	132
125	5	AK12	127	130	254	127.0	213	78	442	322	162	157.0	157.0	77	75
		AK15							471	336	162	195.0	195.0	94	90
		AWN13							494	337	162	287.0	287.0	68	132
150	6	AK15	152	160	267	133.5	229	99	491	356	181	195.0	195.0	94	90
		AWN13							542	385	181	287.0	287.0	68	132
		AW17							636	427	181	377.5	377.5	95	176
200	8	AWN13	203	203	292	146.0	243	106	547	417	220	287.0	287.0	68	132
		AW17							668	459	220	377.5	377.5	95	176
		AW20							756	512	220	530.0	530.0	115	232

Flange Dimensions (mm)

D : Outside diameter
C : Bolt circle diameter
G : Raised face diameter
T : Flange thickness
N : Number of bolts
h : Bolt hole size

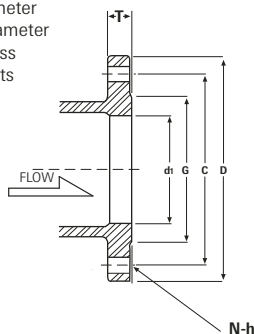

Valve size (mm)	ASME Class 150						ASME Class 300					
	D	C	G	T	N	h	D	C	G	T	N	h
25	108	79.5	60*	11.2	4	16	124	89.0	60*	17.5	4	19
40	127	98.5	81*	14.3	4	16	156	114.5	81*	20.7	4	22
50	152	120.5	96*	15.9	4	19	165	127.0	96*	22.3	8	19
65	178	139.5	116*	17.5	4	19	190	149.0	116*	25.4	8	22
80	190	152.5	127	19.1	4	19	210	168.0	127	28.6	8	22
100	229	190.5	157	23.9	8	19	254	200.0	157	31.8	8	22
125	254	216.0	186	23.9	8	22	279	235.0	186	35.0	8	22
150	279	241.5	216	25.4	8	22	318	270.0	216	36.6	12	22
200	343	298.5	270	28.6	8	22	381	330.0	270	41.3	12	25

* These dimensions differ from ASME standard. For JIS, the flange dimensions are same as JIS standard.

KTM Dual V High Performance Control Ball Valves

Flanged and Flangeless

KTM Model Coding System

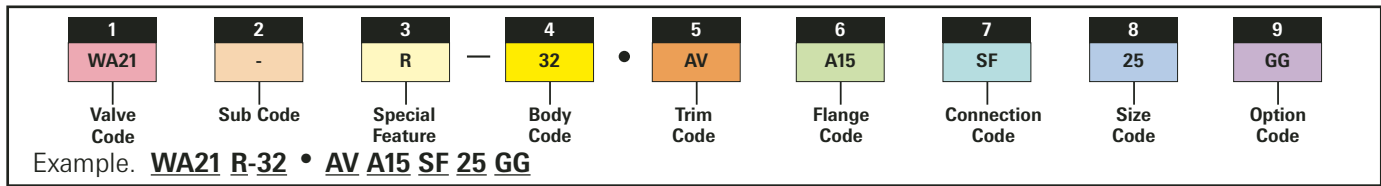

1			
Valve Code	Class	Description	
	ASME	JIS	
WA20	150 / 300	10K / 20K	Reduced bore, Flangeless 25mm to 200mm
WA21	150	10K	Reduced bore, 25mm to 200mm
WA22	300	20K	Reduced bore, 25mm to 200mm

2	
Sub Code	Description
Blank	Metal Seat

3	
Special Feature	Description
Blank	No Special Feature
D	Direct action
R	Reverse action

4		
Body Code	Material	
	JIS	ASTM
31	SCS13A (304SS)	CF8 (304SS)
32	SCS14A (316SS)	CF8M (316SS)

5					
Trim Code					
	Ball JIS	ASTM	Saet	Packing	Stem
AV	SCS14A with HCr	CF8M with HCr	316SS with Stellite	PTFE / FKM O-ring	329J1 SS
AT	SCS14A with HCr	CF8M with HCr	316SS with Stellite	PTFE / PTFE Seal-ring	329J1 SS
BV	SCS14A with SFNi	CF8M with SFNi	316SS with Stellite	PTFE / FKM O-ring	329J1 SS
BT	SCS14A with SFNi	CF8M with SFNi	316SS with Stellite	PTFE / PTFE Seal-ring	329J1 SS
BP	SCS14A with SFNi	CF8M with SFNi	316SS with Stellite	Graphite / PTFE Seal-ring	329J1 SS

HCr : Hard chromiumu plating
SFNi : Electro less Nickel Plating

6	
Flange Code	Description
ASME	
A15	ASME Class 150
A30	ASME Class 300
JIS	
J10	JIS 10K
J20	JIS 20K

7	
Connection Code	Description
Blank	Raised Face
SF	Smooth Finish 125 to 250 AARH

8		
Size Code	mm	Inch
25	25	1
40	40	1½
50	50	2
65	65	2½
80	80	3
100	100	4
125	125	5
150	150	6
200	200	8

9	
Option Code	Description
Blank	No additional option
B1	Buffing (All wetted Parts)
GG	Packing / Gasket-Graphite